

Centrifugal pumps

ps



Centrifugal Pumps

The YUKOS Highlight™ centrifugal pump features a rugged design with heavy duty construction that reduces downtime and total cost of ownership for operators and contractors in today's highly competitive drilling industry.

MULTIPLE APPLICATIONS

Manufactured from wear resistant materials, the Highlight™ centrifugal pump can be used in a multitude of applications from handling abrasive cement and drilling fluids in the oil and gas industry, to waste disposal applications in the agriculture industry.

DIVERSE OPERATING RANGE

The Highlight™ pump line features seven different fluid end sizes and 100+ impeller sizes for fluid flows from as little as 160 gpm to as much as 2500 gpm.

DIMENSIONAL ENVELOPE

The Highlight™ conforms to the industry standard dimensional envelope in the oil and gas drilling and well service industry.

GLOBAL DISTRIBUTION

YUKOS has global distribution with offices and distributors located in major geographic oil and gas regions.

PROLONGED RUN TIMES

Wear resistant fluid end materials provide extended run times on critical wear components.

PREVENT COSTLY FAILURES

YUKOS's 2-1/2" pump shaft is highly resistant to deflections induced by the pump impeller and helps prevent costly failure of optional mechanical seals.

IMPROVED FLUID FLOW

Wide vane impellers allow for improved fluid flow dynamics and high fluid volume.

IMPROVED OVERALL FATIGUE RESISTANCE

Heavy-duty power end construction improves overall fatigue resistance through strengthening mass in critical stress areas.

IMPROVED BEARING LIFE

Heavy duty inboard roller bearings provide additional bearing area for longer bearing and mechanical seal life.

REDUCE MAINTENANCE

Optional mechanical seal reduces maintenance and improves long-term maintenance procedures.

FULL OPEN IMPELLER

Minimizes induced shaft loading.

ENHANCED PUMP EFFICIENCY

Concentric casing reduces turbulence and enhances fluid end life.



Yukos Petroleum Equipment Co. LTD.

Kenli Economic Development Zone Yongfeng Road 66, Dongying, Shandong, China

Tel: + 0546-2388099

Email: jzg@sdyks.cn

Service Email: jzg@sdyks.cn

Pump size	Size	Stroke	Flow	Pressure	Temperature	Material	Mounting	Options	Accessories	Notes
HCPSS3X2X13	60	4	3R	6	4	5	X	X	X	
HCPSS4X3X13	4	3	7R	4	3	5	X	X	X	
HCPSS5X4X14	5	3	7R	4	3	5	X	X	X	
HCPSS6X5X11	6	3	7R	4	3	5	X	X	X	
HCPSS6X5X14	6	3	7R	4	3	5	X	X	X	
HCPSS6X5X11	6	3	7R	4	3	5	X	X	X	
HCPSS6X5X14	6	3	7R	4	3	5	X	X	X	
HCPSS6X5X11	6	3	7R	4	3	5	X	X	X	
HCPSS6X5X14	6	3	7R	4	3	5	X	X	X	

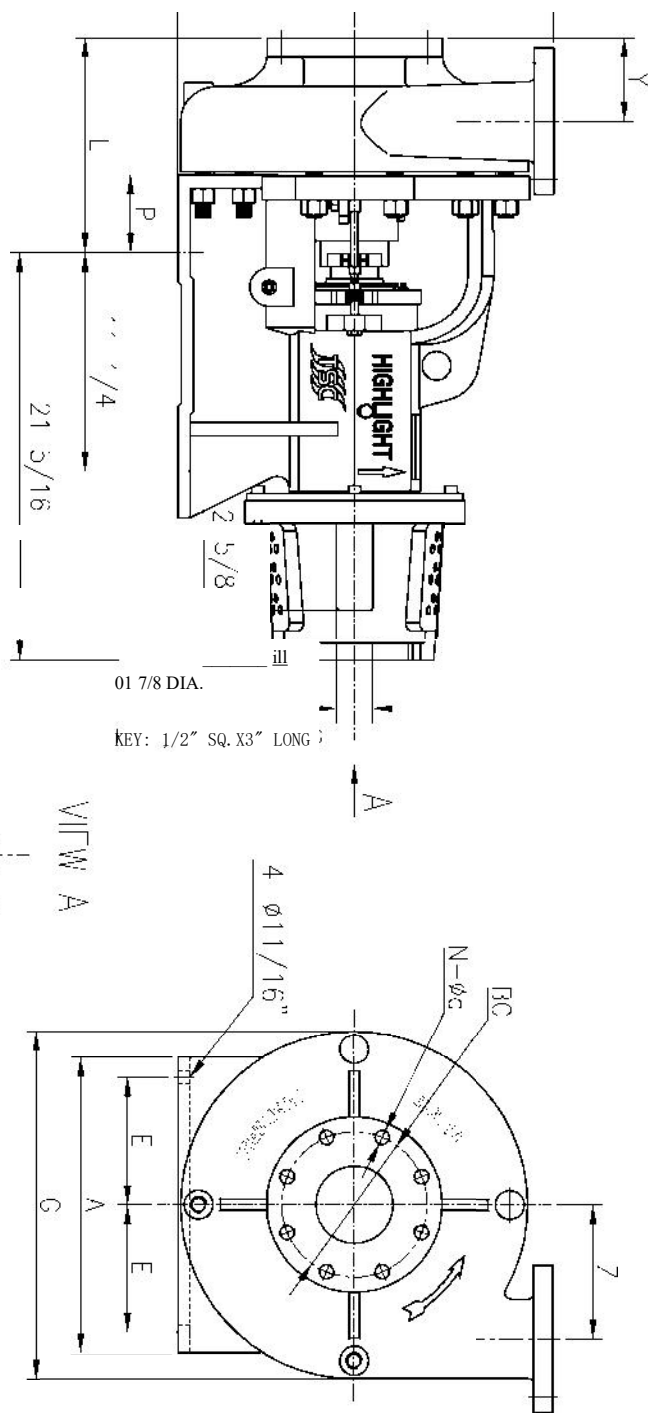
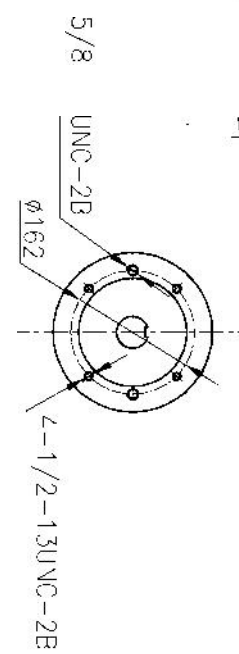

Centrifugal Pumps

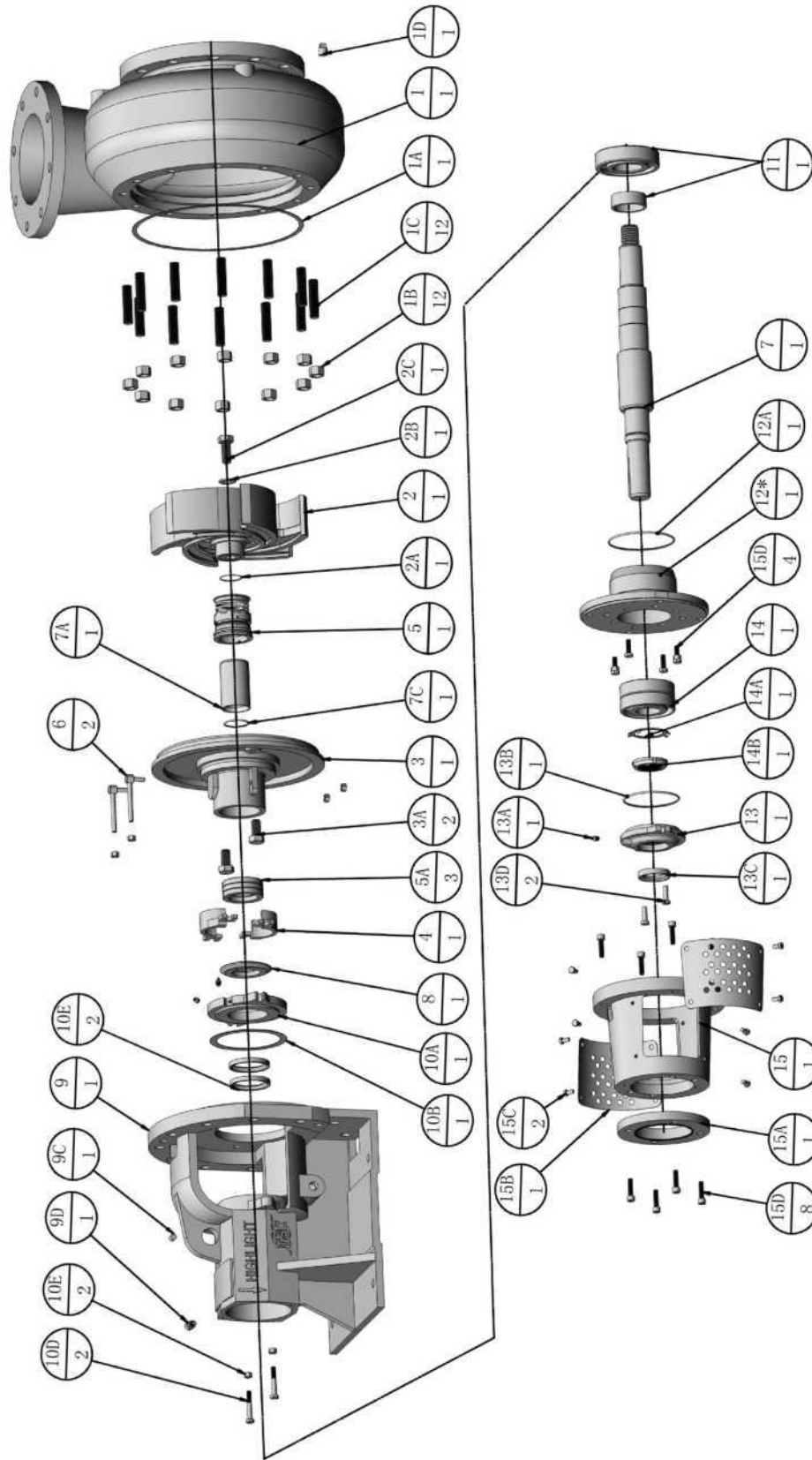

10A	1	20626	YUKOS-20626	Cover, Inboard Bearing	Iron	2*	1	19121-XX-30	YUKOS-19121-XX-30	Impeller, 6x5x11	Hard Iron
10B	1	20625	YUKOS-20625	Gasket, I.B. Bearing Cover	Vegetable Fiber	2*	1	19121-XX-30	YUKOS-19121-XX-30	Impeller, 6x5x14	Hard Iron
10C	1	20619-01	YUKOS-20619-01	Oil Seal, I.B. Bearing Cover	Buna-n	2*	1	19121-XX-30	YUKOS-19121-XX-30	Impeller, 8x6x11	Hard Iron
10D	2	Jan- 61	YUKOS-3861-1	Bolt, I.B. Bearing Cover	Stl	2*	1	19116-XX-30	YUKOS-19116-XX-30	Impeller, 8x6x14	Hard Iron
10E	2	Feb-32	YUKOS-3932-2	Nut, I.B. Brg. Cover	Stl	2*	1	21867-XX-30	YUKOS-21867-XX-30	Impeller, 10x8x14	Hard Iron

Yukos Petroleum Equipment Co. LTD.
Kenli Economic Development Zone Yongfeng Road 66, Dongying, Shandong, China
Tel:+ 0546-2388099
Email: jzg@sydys.cn
Service Email: jzg@sydys.cn

Curve:804

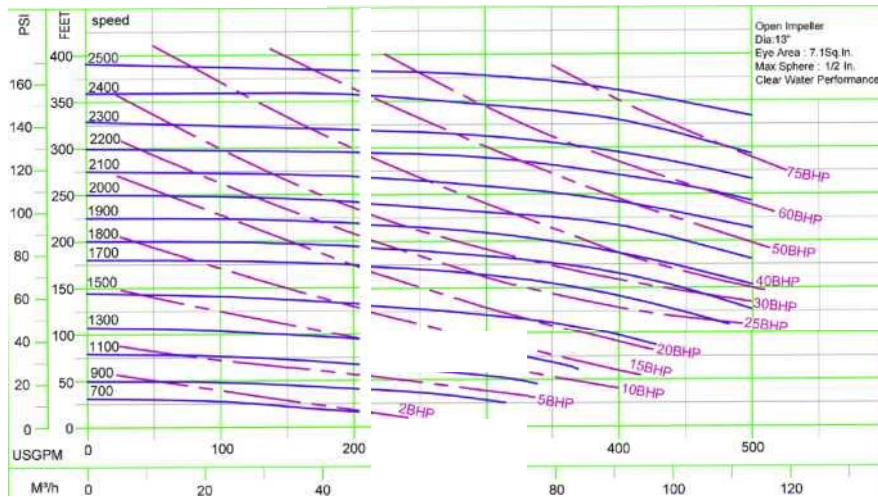

HIGHLIGHT 4x3x13 1000-2400RPM

Curve:812

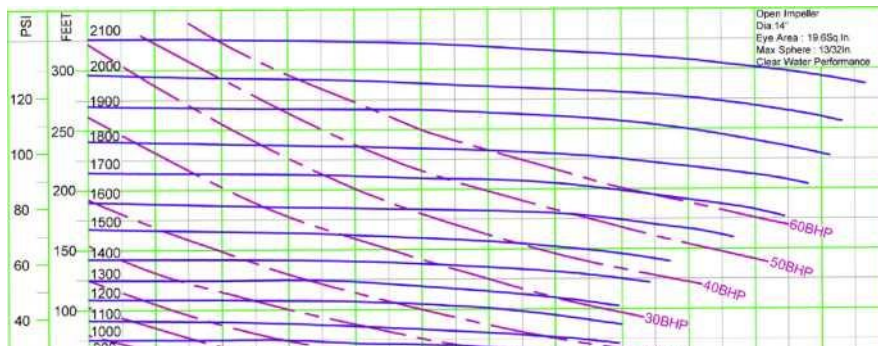
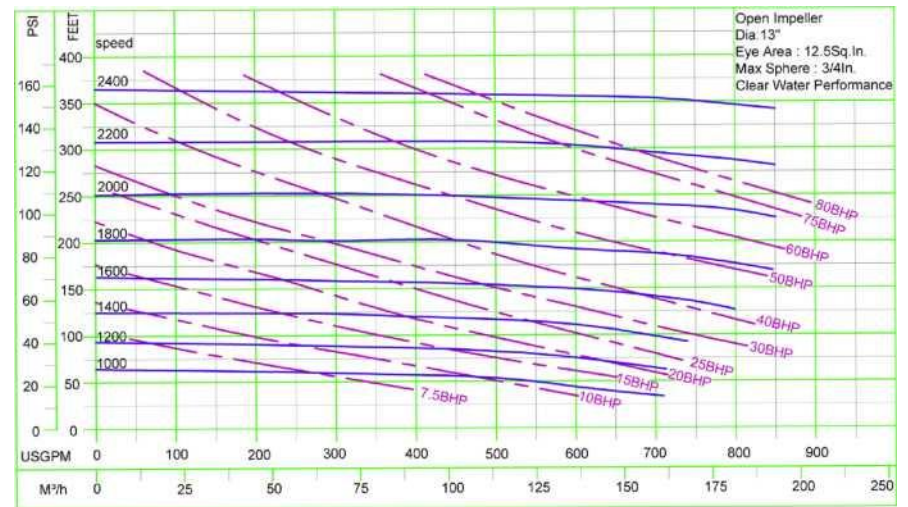

HIGHLIGHT 6x5x11 800~1900RPM

Curve:822

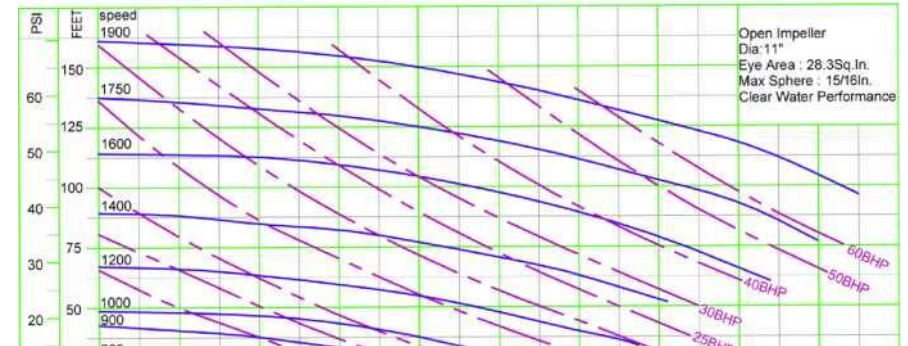

HIGHLIGHT 6x5x14 800-1800RPM

Curve:827

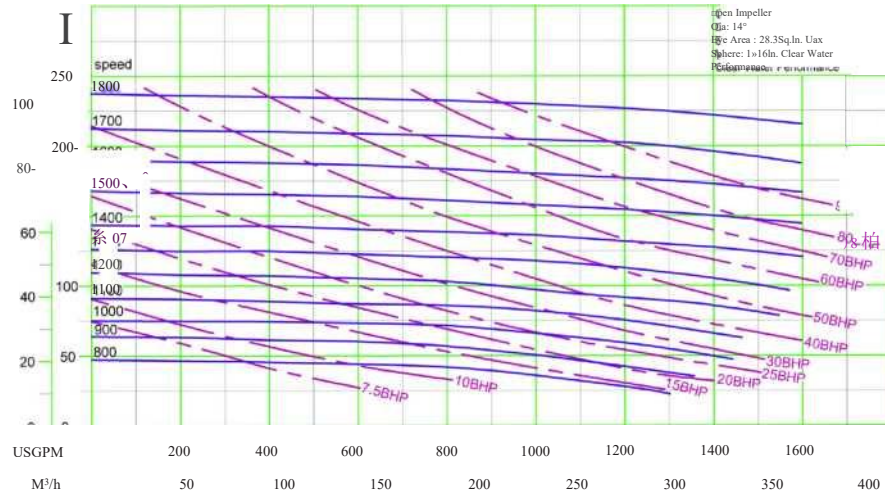

HIGHLIGHT 8x6x11 800-1800RPM

Curve:832

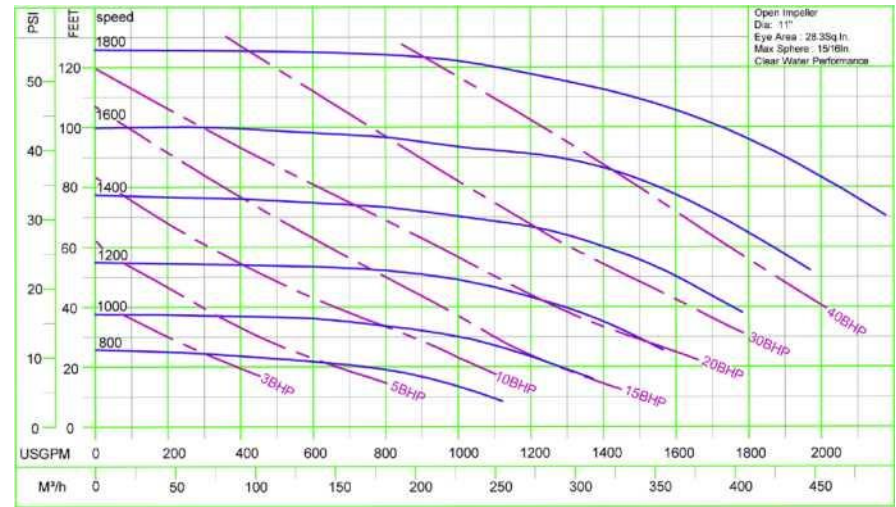

HIGHLIGHT 8x6x14 800-1700RPM

Curve:837

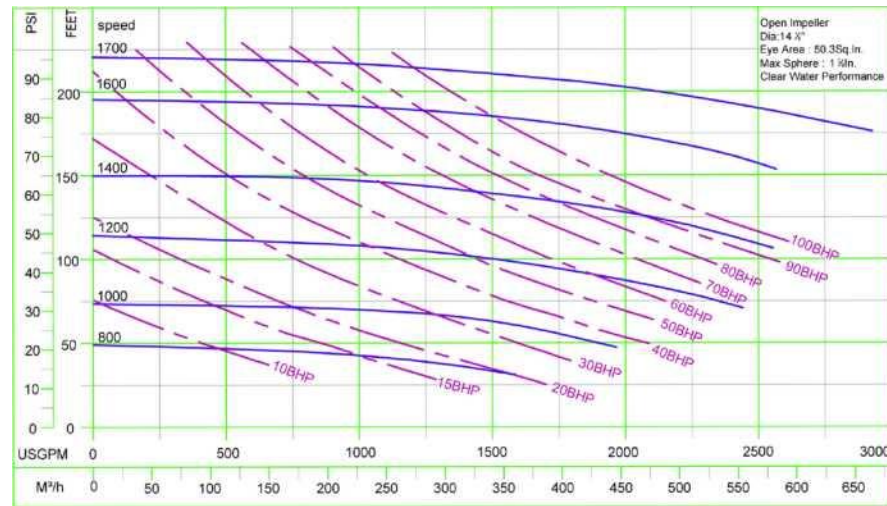

HIGHLIGHT 10x8x14 800-1800RPM

Curve:842

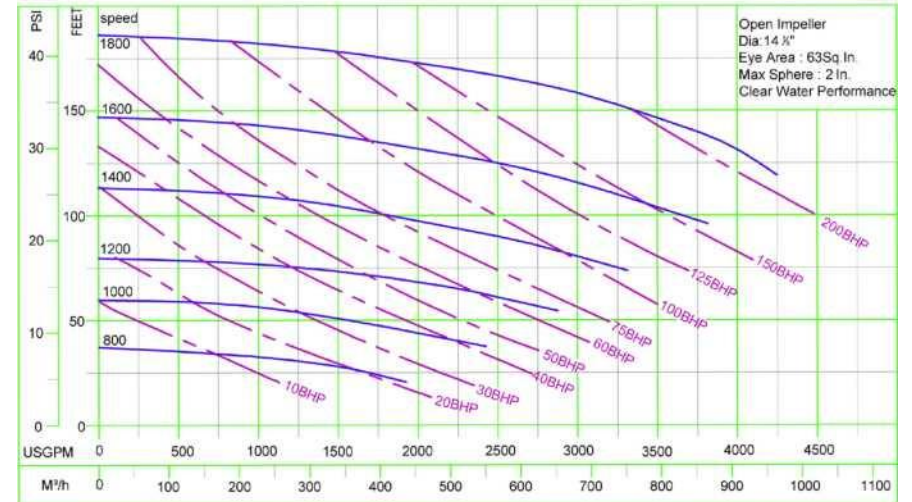

YUKOS GROUP

Yukos Petroleum Equipment Co. LTD.

Kenli Economic Development Zone Yongfeng Road 66, Dongying, Shandong, China

Tel:+ 0546-2388099

Email: jzg@sdyks.cn

Service Email: jzg@sdyks.cn

GLOBAL SOLUTIONS - DESIGNING, MANUFACTURING AND PACKAGING FOR THE OFFSHORE INDUSTRY

Yukos Petroleum Equipment Co. LTD.

Kenli Economic Development Zone Yongfeng Road 66, Dongying, Shandong, China

Tel:+ 0546-2388099

Email: jzg@sdyks.cn

Service Email: jzg@sdyks.cn